

ALLIANCE WINDOW COMPANY, INC

Commercial Aluminum Windows & Doors

PRODUCT INFORMATION:
 FIXED/ PROJECTED WINDOW
 2000 SERIES
 2" FRAME DEPTH
 MFG CODE: 2500 HC PIOG
 - AAMA HC-80 RATED
 - CRF OF 58
 - STC 39
 - 120 PSF STRUCTURAL
 - 18 PSF WATER

*NON-THERMAL FRAME SHOWN ALSO
 AVAILABLE WITH THERMAL FRAMING

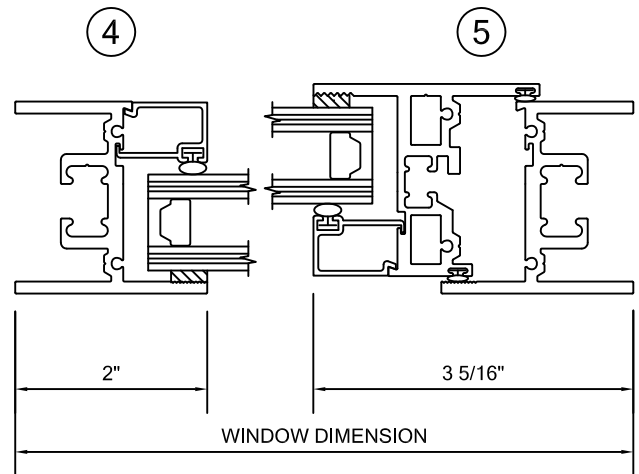
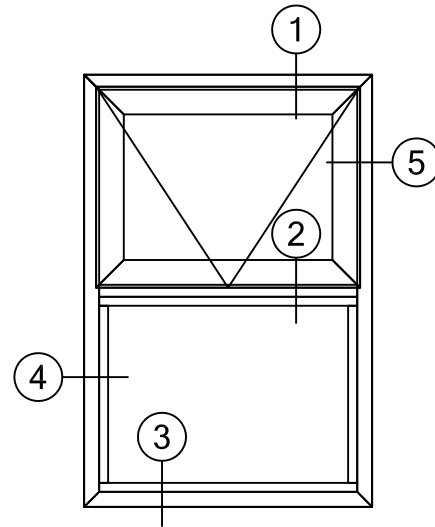
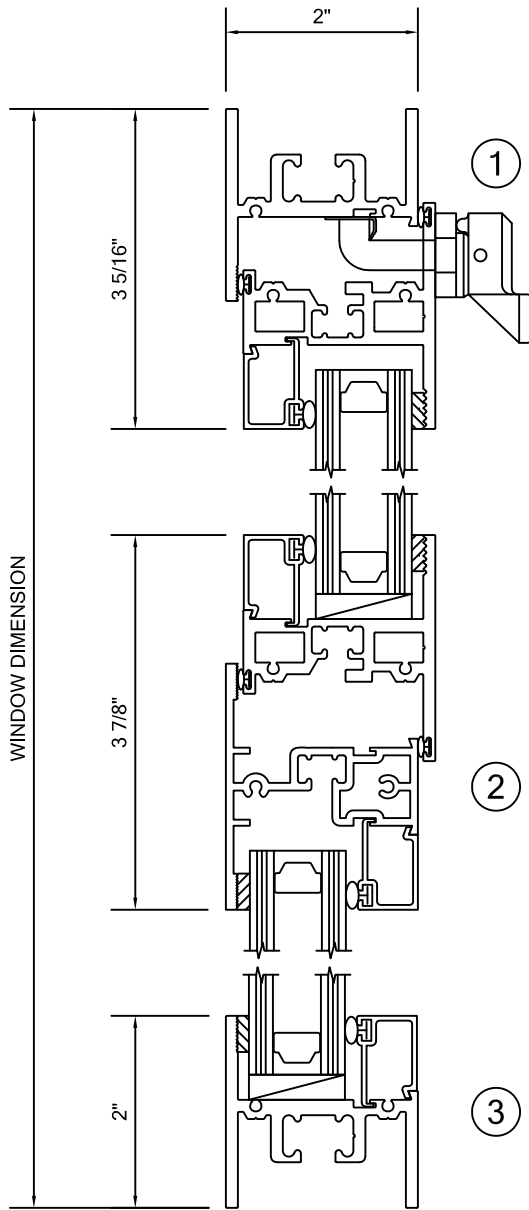

*FRAMING SHOWN AS EQUAL LEG, ALSO AVAILABLE IN NAIL FIN,
 FLANGE FRAME AND PROJECT SPECIFIC APPLICATIONS.